

WALL & CEILING MOUNTS

BY  **EUROfase**
LIGHTING



CONTENTS



Ceiling Mount

1 - 56



Wall Mount

57 - 96

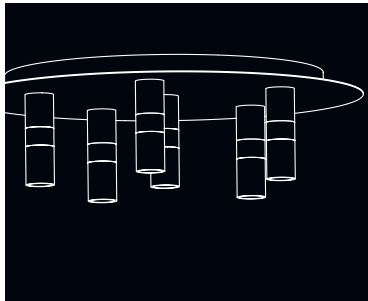

CEILING MOUNT



CEILING MOUNT

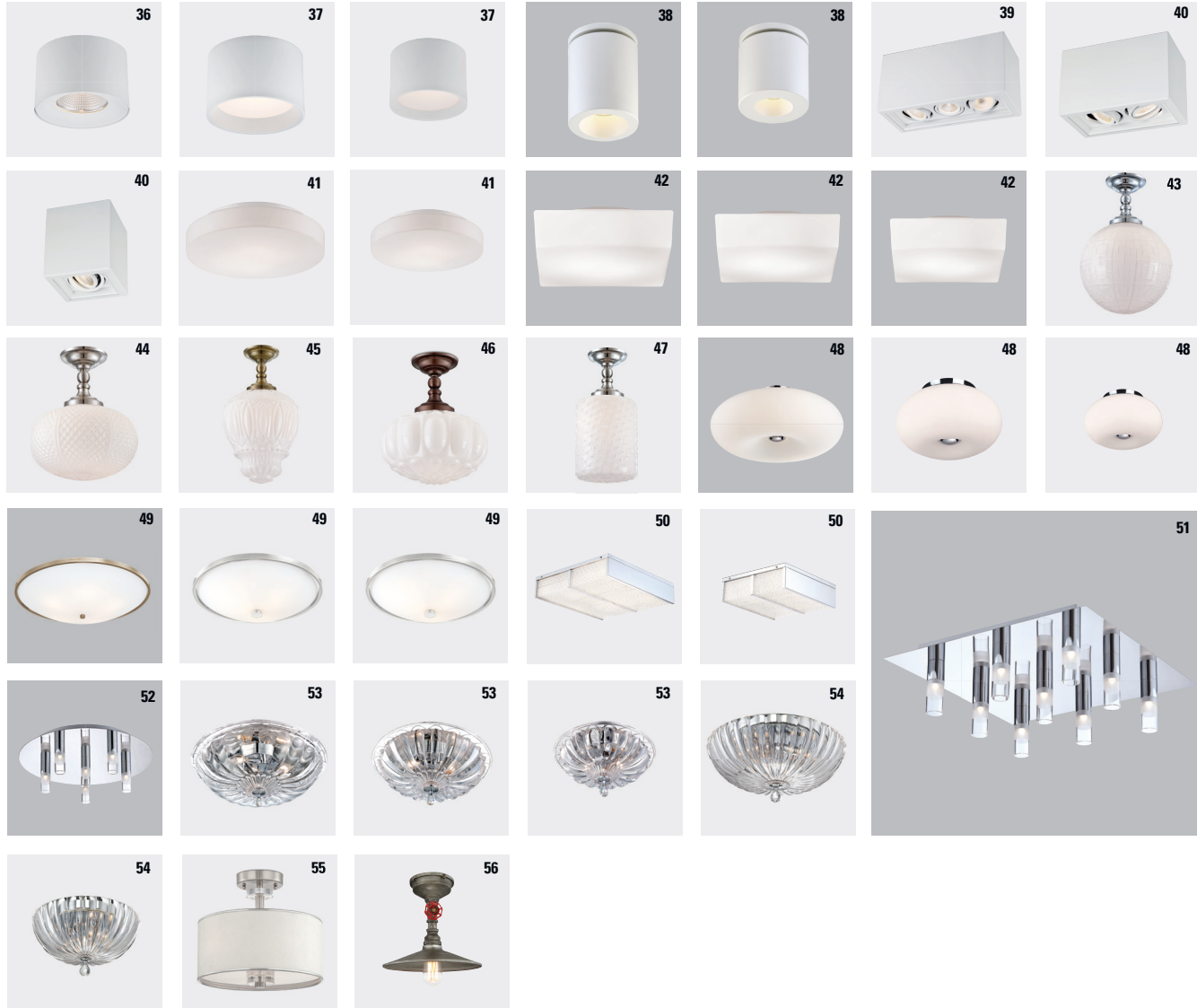

THUMBNAILS

WALL MOUNT







WALL MOUNT





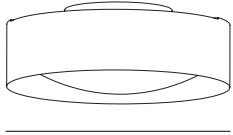

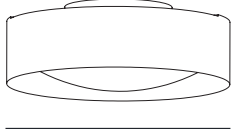

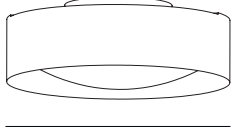

SATURN

	ITEM #	KELVIN	FINISH	SHADE	WATT	LUMEN	CRI	DIMMABLE
 4 3/4"  ø15 1/2"	30105-010	3000K	CHROME	OPAL WHITE GLASS	24W LED	1350lm	80+	TRIAC
 4 3/4"  ø15 1/2"	30105-027	3000K	SATIN NICKEL	OPAL WHITE GLASS	24W LED	1350lm	80+	TRIAC
 4 3/4"  ø15 1/2"	30105-034	3000K	WHITE	OPAL WHITE GLASS	24W LED	1350lm	80+	TRIAC

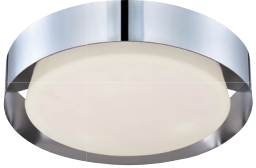
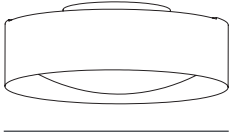
For customization please consult Eurofase

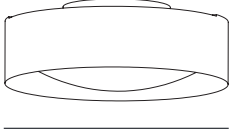
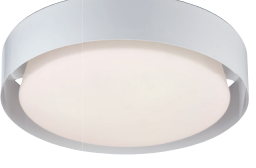
SATURN

	ITEM #	FINISH	SHADE	WATT	SOCKET	BULB
 4 3/4"  ø15 1/2"	25732-023	CHROME	OPAL WHITE GLASS	3 X 60W	E26	A19 (Not Included)
 4 3/4"  ø15 1/2"	25732-016	SATIN NICKEL	OPAL WHITE GLASS	3 X 60W	E26	A19 (Not Included)
 4 3/4"  ø15 1/2"	25732-030	WHITE	OPAL WHITE GLASS	3 X 60W	E26	A19 (Not Included)

CEILING MOUNT





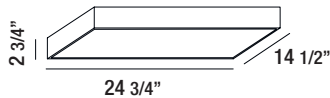

MAC

	ITEM #	KELVIN	FINISH	SHADE	WATT	LUMEN	CRI	DIMMABLE
 	29003-30-013	3000K	SILVER	WHITE ACRYLIC	24W LED	1900lm	80+	TRIAC
	29003-35-013	3500K						
 	29003-30-023	3000K	WHITE	WHITE ACRYLIC	24W LED	1900lm	80+	TRIAC
	29003-35-023	3500K						

For customization please consult Eurofase



MAC

		ITEM #	KELVIN	FINISH	SHADE	WATT	LUMEN	CRI	DIMMABLE
		29002-30-016	3000K	SILVER	WHITE ACRYLIC	12W LED	950lm	80+	TRIAC
		29002-35-016	3500K						
		29002-30-028	3000K	WHITE	WHITE ACRYLIC	12W LED	950lm	80+	TRIAC
		29002-35-028	3500K						

For customization please consult Eurofase

CEILING MOUNT











BRANT

		ITEM #	KELVIN	FINISH	SHADE	WATT	LUMEN	CRI	DIMMABLE
		32692-30-021	3000K	PLATINUM	WHITE ACRYLIC	27W LED	3000lm	80+	TRIAC
		32692-35-021	3500K						
		32690-30-023	3000K	SATIN NICKEL	WHITE ACRYLIC	24W LED	2000lm	80+	TRIAC
		32690-35-023	3500K						
		29872-30-022	3000K	SATIN NICKEL	WHITE ACRYLIC	18W LED	1600lm	80+	TRIAC
		29872-35-022	3500K						
		29870-30-028	3000K	SATIN NICKEL	WHITE ACRYLIC	14W LED	1100lm	80+	TRIAC
		29870-35-028	3500K						

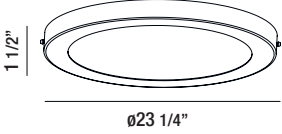
For customization please consult Eurofase

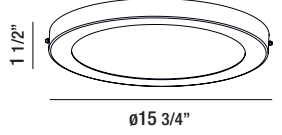

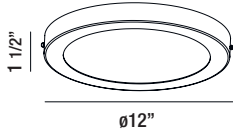
BRANT

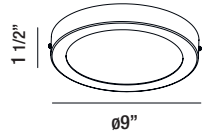

		ITEM #	KELVIN	FINISH	SHADE	WATT	LUMEN	CRI	DIMMABLE
		32692-30-013	3000K	WHITE	WHITE ACRYLIC	27W LED	3000lm	80+	TRIAC
		32692-35-013	3500K						
		32690-30-019	3000K	WHITE	WHITE ACRYLIC	24W LED	2000lm	80+	TRIAC
		32690-35-019	3500K						
		29872-30-015	3000K	WHITE	WHITE ACRYLIC	18W LED	1600lm	80+	TRIAC
		29872-35-015	3500K						
		29870-30-011	3000K	WHITE	WHITE ACRYLIC	14W LED	1100lm	80+	TRIAC
		29870-35-011	3500K						

For customization please consult Eurofase





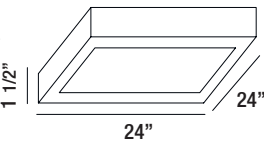
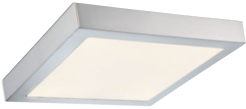
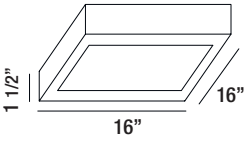
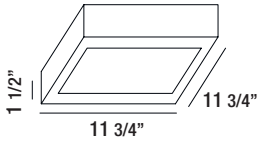

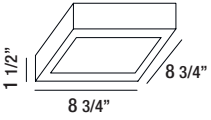

AVON

		ITEM #	KELVIN	FINISH	SHADE	WATT	LUMEN	CRI	DIMMABLE
 	33226-30-026	3000K	PLATINUM	WHITE ACRYLIC	27W LED	3000lm	80+	TRIAC	
	33226-35-026	3500K							
 	33225-30-029	3000K	SATIN NICKEL	WHITE ACRYLIC	24W LED	2000lm	80+	TRIAC	
	33225-35-029	3500K							
 	29873-30-029	3000K	SATIN NICKEL	WHITE ACRYLIC	18W LED	1600lm	80+	TRIAC	
	29873-35-029	3500K							
 	29871-30-025	3000K	SATIN NICKEL	WHITE ACRYLIC	14W LED	1100lm	80+	TRIAC	
	29871-35-025	3500K							

For customization please consult Eurofase

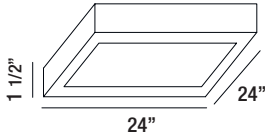

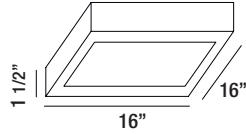
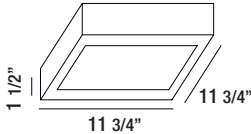
AVON

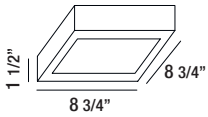

		ITEM #	KELVIN	FINISH	SHADE	WATT	LUMEN	CRI	DIMMABLE
 	33226-30-019	3000K	WHITE	WHITE	27W	3000lm	80+	TRIAC	
	33226-35-019	3500K	WHITE	ACRYLIC	LED				
 	33225-30-012	3000K	WHITE	WHITE	24W	2000lm	80+	TRIAC	
	33225-35-012	3500K	WHITE	ACRYLIC	LED				
 	29873-30-012	3000K	WHITE	WHITE	18W	1600lm	80+	TRIAC	
	29873-35-012	3500K	WHITE	ACRYLIC	LED				
 	29871-30-018	3000K	WHITE	WHITE	14W	1100lm	80+	TRIAC	
	29871-35-018	3500K	WHITE	ACRYLIC	LED				

For customization please consult Eurofase





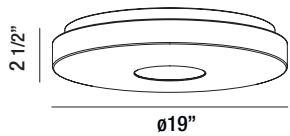

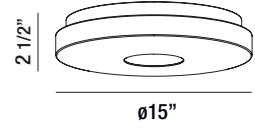
CIRCO

		ITEM #	KELVIN	FINISH	SHADE	WATT	LUMEN	CRI	DIMMABLE
		30131-30-019	3000K	WHITE	WHITE ACRYLIC	37W LED	3000lm	80+	TRIAC
		30131-35-019	3500K						
		30130-30-012	3000K	WHITE	WHITE ACRYLIC	22W LED	2000lm	80+	TRIAC
		30130-35-012	3500K						

For customization please consult Eurofase

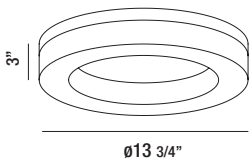

ABELL

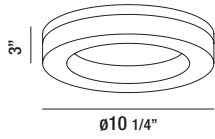
	ITEM #	KELVIN	FINISH	SHADE	WATT	LUMEN	CRI	DIMMABLE
 	30156-012	3000K	CHROME	WHITE ACRYLIC	25W LED	2000lm	80+	TRIAC
 	30155-015	3000K	CHROME	WHITE ACRYLIC	21W LED	1600lm	80+	TRIAC



For customization please consult Eurofase

CEILING MOUNT





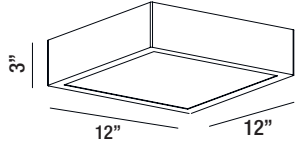

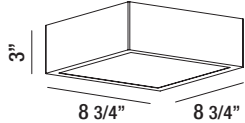

ACARA

	ITEM #	KELVIN	FINISH	SHADE	WATT	LUMEN	CRI	DIMMABLE
 	30160-019	3000K	CHROME	WHITE ACRYLIC	20W LED	1330lm	80+	TRIAC
 	30159-013	3000K	CHROME	WHITE ACRYLIC	14W LED	1170lm	80+	TRIAC

For customization please consult Eurofase

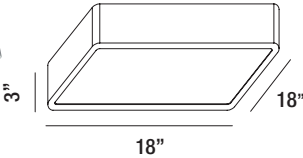

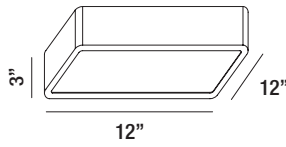
BAYS

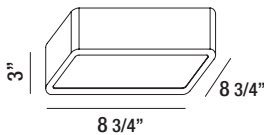
		ITEM #	KELVIN	FINISH	SHADE	WATT	LUMEN	CRI	DIMMABLE
 		30163-010	3000K	CHROME	WHITE ACRYLIC	36W LED	2340lm	80+	TRIAC
 		30162-013	3000K	CHROME	WHITE ACRYLIC	28W LED	1820lm	80+	TRIAC
 		30161-016	3000K	CHROME	WHITE ACRYLIC	14W LED	1170lm	80+	TRIAC



For customization please consult Eurofase

CEILING MOUNT



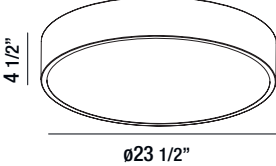

NAPOLEON

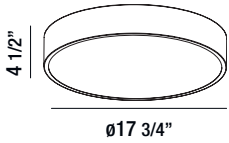
	ITEM #	KELVIN	FINISH	SHADE	WATT	LUMEN	CRI	DIMMABLE
  <p>4 1/2" ø23 1/2"</p>	32695-014	3000K	WHITE	WHITE ACRYLIC	40W LED	3600lm	80+	TRIAC
  <p>4 1/2" ø17 3/4"</p>	32694-017	3000K	WHITE	WHITE ACRYLIC	30W LED	2700lm	80+	TRIAC

For customization please consult Eurofase



MUIR

		ITEM #	KELVIN	FINISH	SHADE	WATT	LUMEN	CRI	DIMMABLE
 		30141-018	3000K	SATIN NICKEL	OPAL WHITE GLASS	28W LED	2350lm	80+	TRIAC
 		30142-015	3000K	SATIN NICKEL	OPAL WHITE GLASS	18W LED	1580lm	80+	TRIAC





For customization please consult Eurofase

CEILING MOUNT



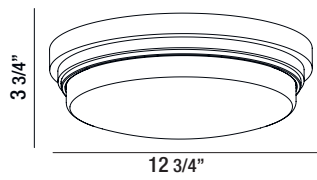

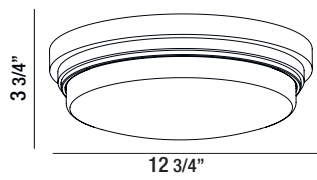

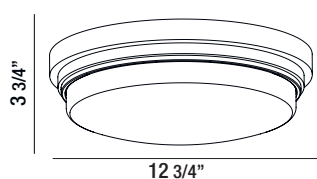
WILSON

		ITEM #	KELVIN	FINISH	SHADE	WATT	LUMEN	CRI	DIMMABLE
 		26635-019	2700K	BRONZE	OPAL WHITE GLASS	25W LED	2500lm	85+	TRIAC
 		26635-026	2700K	SATIN NICKEL	OPAL WHITE GLASS	25W LED	2500lm	85+	TRIAC
 		26635-033	2700K	CHROME	OPAL WHITE GLASS	25W LED	2500lm	85+	TRIAC

For customization please consult Eurofase

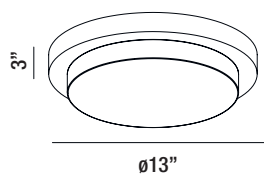

SALBA

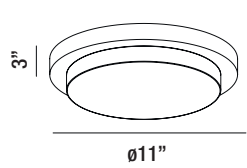
	ITEM #	KELVIN	FINISH	SHADE	WATT	LUMEN	CRI	DIMMABLE
 	30150-010	3000K	CHROME	OPAL WHITE GLASS	28W LED	2350lm	80+	TRIAC
 	30149-014	3000K	CHROME	OPAL WHITE GLASS	18W LED	1580lm	80+	TRIAC



For customization please consult Eurofase

CEILING MOUNT



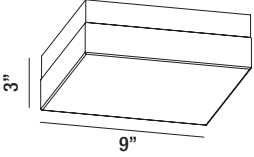

DIXON

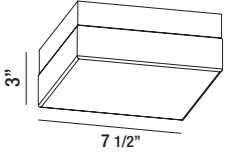
		ITEM #	KELVIN	FINISH	SHADE	WATT	LUMEN	CRI	DIMMABLE
 		30154-018	3000K	CHROME	OPAL WHITE GLASS	18W LED	1580lm	80+	TRIAC
 		30153-011	3000K	CHROME	OPAL WHITE GLASS	9W LED	790lm	80+	TRIAC

For customization please consult Eurofase



KOSS

	ITEM #	KELVIN	FINISH	SHADE	WATT	LUMEN	CRI	DIMMABLE
	30152-014	3000K	CHROME	OPAL WHITE GLASS	18W LED	1600lm	80+	TRIAC
	30151-017	3000K	CHROME	OPAL WHITE GLASS	9W LED	800lm	80+	TRIAC



For customization please consult Eurofase

CEILING MOUNT



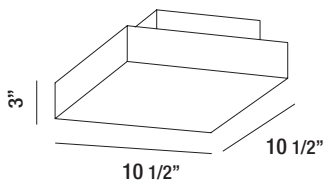

MONTI

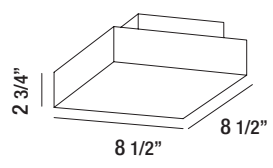
		ITEM #	KELVIN	FINISH	SHADE	WATT	LUMEN	CRI	DIMMABLE
 		30169-012	3000K	SATIN NICKEL	OPAL WHITE GLASS	18W LED	1580lm	80+	TRIAC
 		30170-018	3000K	SATIN NICKEL	OPAL WHITE GLASS	14W LED	1170lm	80+	TRIAC

For customization please consult Eurofase



ELLSWORTH

ITEM # KELVIN FINISH SHADE WATT LUMEN CRI DIMMABLE

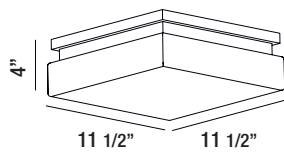

26632-018 2700K BRONZE OPAL WHITE GLASS 12W LED 1000lm 85+ TRIAC

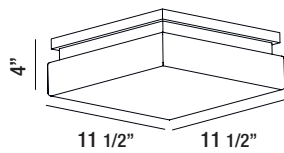

26632-025 2700K SATIN NICKEL OPAL WHITE GLASS 12W LED 1000lm 85+ TRIAC

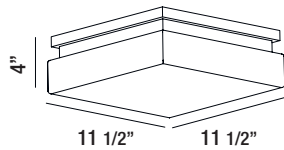

26632-032 2700K CHROME OPAL WHITE GLASS 12W LED 1000lm 85+ TRIAC



For customization please consult Eurofase

CEILING MOUNT





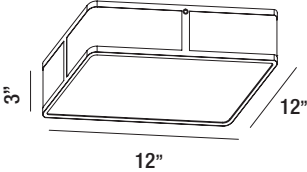

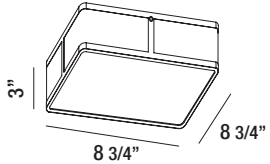
FLYNN

		ITEM #	KELVIN	FINISH	SHADE	WATT	LUMEN	CRI	DIMMABLE
 		30157-019	3000K	CHROME	OPAL WHITE GLASS	20W LED	1330lm	80+	TRIAC
 		30158-016	3000K	CHROME	OPAL WHITE GLASS	14W LED	1170lm	80+	TRIAC

For customization please consult Eurofase

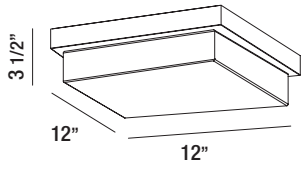

BARLOW

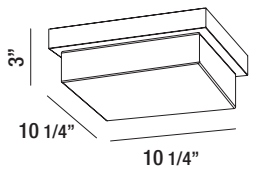
	ITEM #	KELVIN	FINISH	SHADE	WATT	LUMEN	CRI	DIMMABLE
 	32673-012	3000K	CHROME	WHITE ACRYLIC	16W LED	1300lm	80+	TRIAC
 	32672-015	3000K	CHROME	WHITE ACRYLIC	13W LED	1200lm	80+	TRIAC





For customization please consult Eurofase

CEILING MOUNT



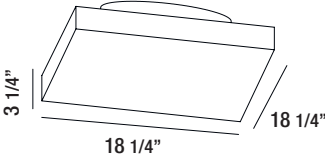

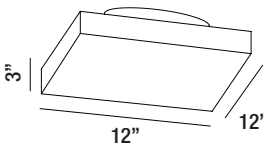

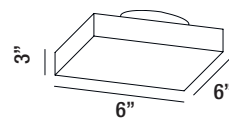
EVOLVE

		ITEM #	KELVIN	FINISH	SHADE	WATT	LUMEN	CRI	DIMMABLE
 	30167-30-018	3000K	CHROME	WHITE ACRYLIC	35W LED	2970lm	80+	TRIAC	
	30167-35-018	3500K							
 	30166-30-011	3000K	CHROME	WHITE ACRYLIC	24W LED	2040lm	80+	TRIAC	
	30166-35-011	3500K							
 	30164-30-017	3000K	CHROME	WHITE ACRYLIC	6W LED	510lm	80+	TRIAC	
	30164-35-017	3500K							

For customization please consult Eurofase

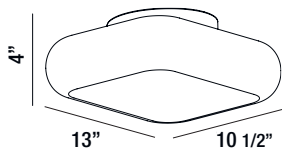

ALMA

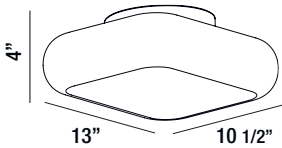
	ITEM #	KELVIN	FINISH	SHADE	WATT	LUMEN	CRI	DIMMABLE
 	26631-011	2700K	BRONZE	OPAL WHITE GLASS	2 x 8W LED	2970lm	85+	TRIAC
 	26631-028	2700K	SATIN NICKEL	OPAL WHITE GLASS	2 x 8W LED	1300lm	85+	TRIAC





For customization please consult Eurofase

CEILING MOUNT



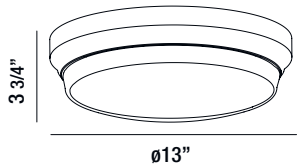

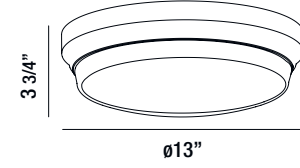

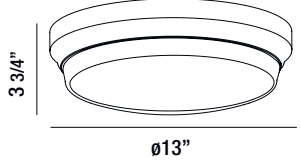

JANE

	ITEM #	KELVIN	FINISH	SHADE	WATT	LUMEN	CRI	DIMMABLE
 	26634-012	2700K	BRONZE	FROSTED GLASS	12W LED	1000lm	85+	TRIAC
 	26634-029	2700K	SATIN NICKEL	FROSTED GLASS	12W LED	1000lm	85+	TRIAC
 	26634-036	2700K	CHROME	FROSTED GLASS	12W LED	1000lm	85+	TRIAC

For customization please consult Eurofase

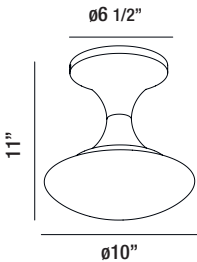

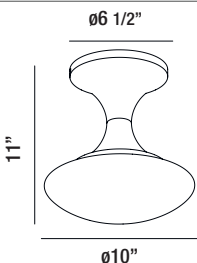
DALLNER

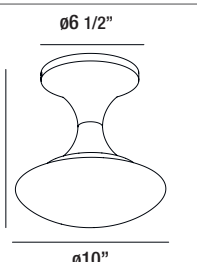

	ITEM #	KELVIN	FINISH	SHADE	WATT	LUMEN	CRI	DIMMABLE
 	26633-015	3000K	BRONZE	OPAL WHITE GLASS	20W LED	1180lm	90+	TRIAC
 	26633-022	3000K	SATIN NICKEL	OPAL WHITE GLASS	20W LED	1180lm	90+	TRIAC
 	26633-039	3000K	CHROME	OPAL WHITE GLASS	20W LED	1180lm	90+	TRIAC

For customization please consult Eurofase





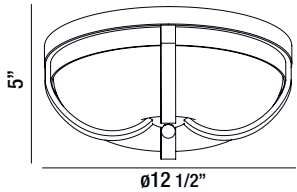

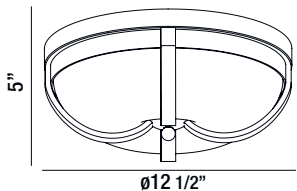
ANDREW

		ITEM #	KELVIN	FINISH	SHADE	WATT	LUMEN	CRI	DIMMABLE
		26637-020	2700K	BRONZE	OPAL WHITE GLASS	2 X 8W LED	1300lm	85+	TRIAC
		26637-013	2700K	SATIN NICKEL	OPAL WHITE GLASS	2 X 8W LED	1300lm	85+	TRIAC

For customization please consult Eurofase



KATE





		ITEM #	KELVIN	FINISH	SHADE	WATT	LUMEN	CRI	DIMMABLE
 	26636-023	2700K	BRONZE	OPAL WHITE GLASS	2 X 8W LED	1300lm	85+	TRIAC	
 	26636-016	2700K	SATIN NICKEL	OPAL WHITE GLASS	2 X 8W LED	1300lm	85+	TRIAC	

For customization please consult Eurofase

CEILING MOUNT

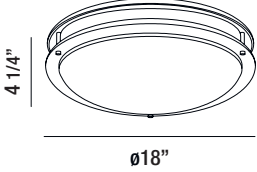

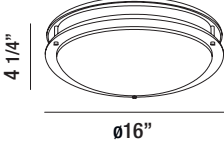
WARDEN

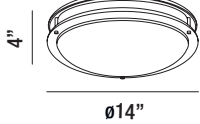
		ITEM #	KELVIN	FINISH	SHADE	WATT	LUMEN	CRI	DIMMABLE
		30126-30-015	3000K	SATIN	WHITE	27W	1780lm	80+	TRIAC
		30126-35-015	3500K	NICKEL	ACRYLIC	LED			
		30125-30-018	3000K	SATIN	WHITE	20W	1330lm	80+	TRIAC
		30125-35-018	3500K	NICKEL	ACRYLIC	LED			
		30124-30-011	3000K	SATIN	WHITE	13W	900lm	80+	TRIAC
		30124-35-011	3500K	NICKEL	ACRYLIC	LED			

For customization please consult Eurofase



JAVA

ITEM #	KELVIN	FINISH	SHADE	WATT	LUMEN	CRI	DIMMABLE
--------	--------	--------	-------	------	-------	-----	----------

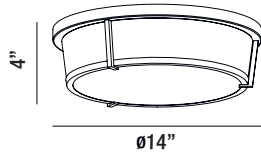

30140-011	3000K	SATIN NICKEL	WHITE ACRYLIC	18W LED	1600lm	80+	TRIAC
-----------	-------	--------------	---------------	---------	--------	-----	-------

For customization please consult Eurofase



ELEMENT

ITEM #	KELVIN	FINISH	SHADE	WATT	LUMEN	CRI	DIMMABLE
--------	--------	--------	-------	------	-------	-----	----------

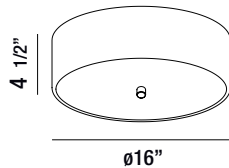

33227-30-016	3000K	BRUSHED NICKEL	FROSTED GLASS	30W LED	3150lm	80+	TRIAC
33227-35-016	3500K	NICKEL	GLASS	LED			



For customization please consult Eurofase

CEILING MOUNT



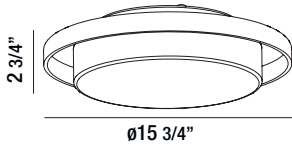

LOGEN

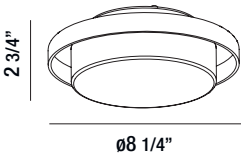
		ITEM #	KELVIN	FINISH	SHADE	WATT	LUMEN	CRI	DIMMABLE
		29816-019	3000K	WHITE	CLEAR AND OPAL WHITE GLASS	20W LED	1600lm	80+	TRIAC
		29815-012	3000K	WHITE	CLEAR AND OPAL WHITE GLASS	7.5W LED	675lm	80+	TRIAC

For customization please consult Eurofase



Wall Mount Application



NOBLE

ITEM #	LUMEN	FINISH	SHADE	WATT	KELVIN	CRI	DIMMABLE	INSTALLATION
--------	-------	--------	-------	------	--------	-----	----------	--------------

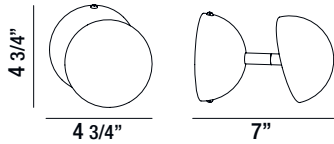
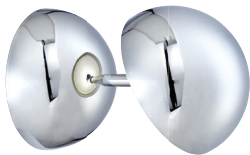

28157-014	540lm	CHROME	Frosted Lens	6W LED	4000K	80+	NO	WALL AND CEILING
-----------	-------	--------	--------------	--------	-------	-----	----	------------------

For customization please consult Eurofase



Ceiling Mount Application

CEILING MOUNT



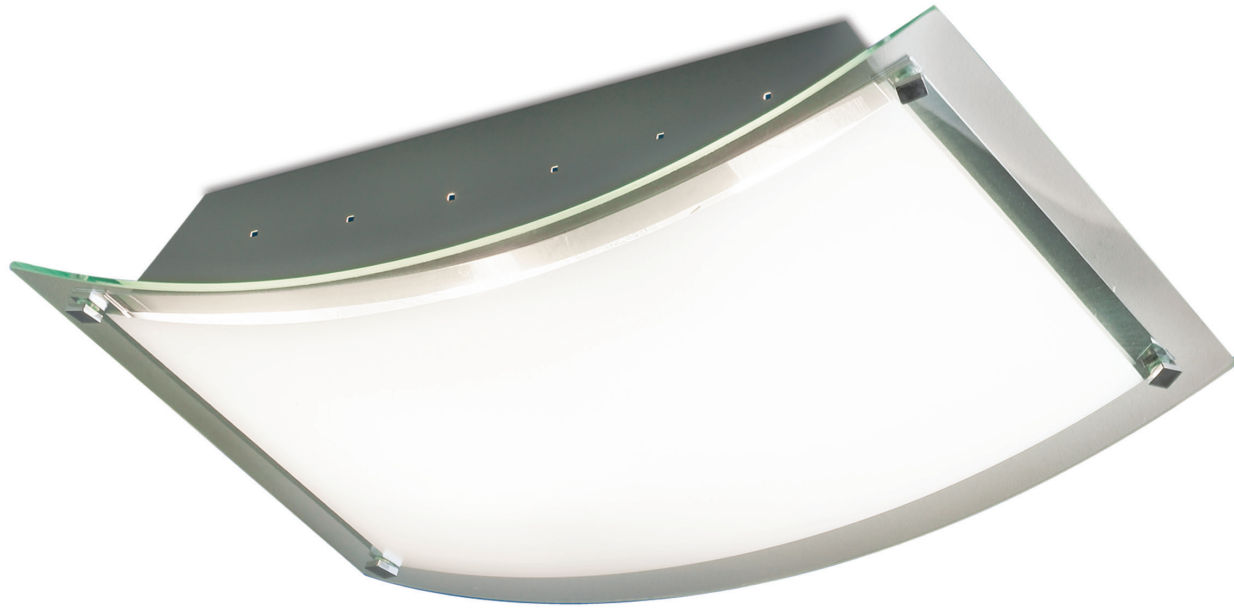

SLEEK

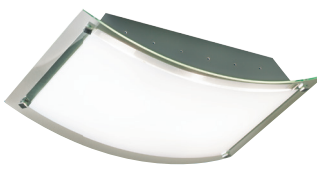
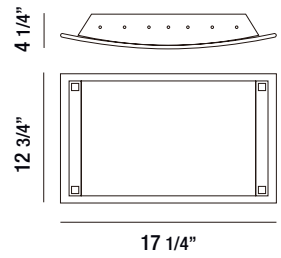
	ITEM #	FINISH	SHADE	WATT	SOCKET	BULB
 	14436-017	Platinum	CLEAR WHITE GLASS	2 X 60W	E26	A19 (Not Included)



FORM

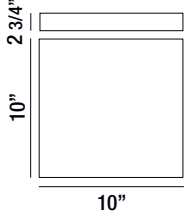
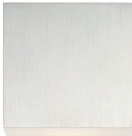
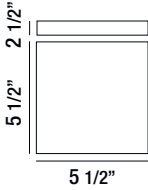

	ITEM #	KELVIN	FINISH	SHADE	WATT	LUMEN	CRI	DIMMABLE	INSTALLATION
 	30172-012	3000K	ALUMINUM	WHITE ACRYLIC	8.6W LED	730lm	80+	TRIAC	WALL AND CEILING
 	30171-015	3000K	ALUMINUM	WHITE ACRYLIC	4.8W LED	408lm	80+	TRIAC	WALL AND CEILING

For customization please consult Eurofase

CEILING MOUNT



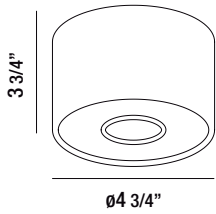

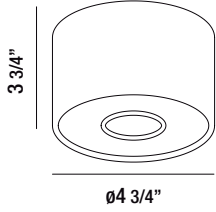
VISION

	ITEM #	KELVIN	FINISH	SHADE	WATT	LUMEN	CRI	DIMMABLE	INSTALLATION
 	29491-018	3000K	BLACK	FROSTED ACRYLIC	5W LED	550lm	80+	TRIAC	WALL AND CEILING
 	29491-025	3000K	WHITE	FROSTED ACRYLIC	5W LED	550lm	80+	TRIAC	WALL AND CEILING

For customization please consult Eurofase

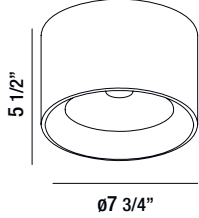

PARKWAY

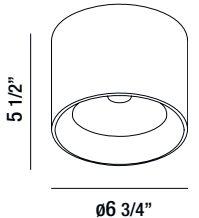
		ITEM #	KELVIN	FINISH	SHADE	WATT	LUMEN	CRI	DIMMABLE
 		32682-014	3500K	WHITE	CLEAR LENS	25W LED	2260lm	80+	TRIAC
 		32681-017	3500K	WHITE	CLEAR LENS	20W LED	1960lm	80+	TRIAC

For customization please consult Eurofase

CEILING MOUNT







BENTON

		ITEM #	KELVIN	FINISH	SHADE	WATT	LUMEN	CRI	DIMMABLE
		32684-018	3500K	WHITE	FROSTED GLASS	25W LED	3160lm	80+	TRIAC
		32683-011	3500K	WHITE	FROSTED GLASS	20W LED	2640lm	80+	TRIAC

For customization please consult Eurofase

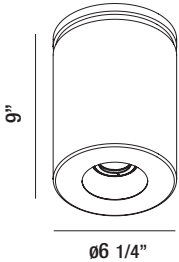

LOTUS

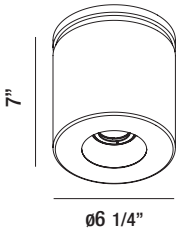
	ITEM #	KELVIN	FINISH	SHADE	WATT	LUMEN	CRI	DIMMABLE
 	30309-012	3000K	WHITE	CLEAR LENS	26W LED	3110lm	80+	TRIAC
 	30310-018*	3000K	WHITE	CLEAR LENS	9W LED	1050lm	80+	TRIAC

* Horizontal adjustment: 0° - 20°

For customization please consult Eurofase

CEILING MOUNT





SANTO

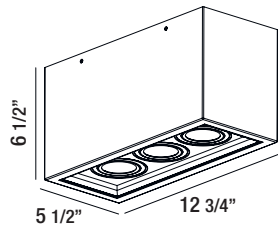

ITEM #	KELVIN	FINISH	SHADE	WATT	LUMEN	CRI	DIMMABLE
--------	--------	--------	-------	------	-------	-----	----------



32689-013*	3500K	WHITE	METAL	33W LED	4440lm	80+	TRIAC
------------	-------	-------	-------	------------	--------	-----	-------

* Horizontal adjustment: 0° - 20°

For customization please consult Eurofase

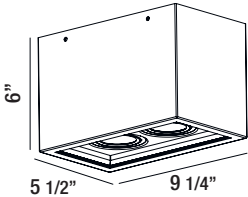

 **SANTO**

		ITEM #	KELVIN	FINISH	SHADE	WATT	LUMEN	CRI	DIMMABLE
		32688-016*	3500K	WHITE	METAL	22W LED	2960lm	80+	TRIAC
		32687-019*	3500K	WHITE	METAL	11W LED	1480lm	80+	TRIAC



* Horizontal adjustment: 0° - 20°

For customization please consult Eurofase

CEILING MOUNT

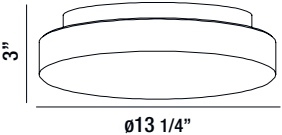

RAMATA

		ITEM #	FINISH	SHADE	WATT	SOCKET	BULB
 		26145-013	WHITE	OPAL WHITE GLASS	2 X 60W	E26	A19 (Not Included)
 		26144-016	WHITE	OPAL WHITE GLASS	1 X 60W	E26	A19 (Not Included)



AMATA







		ITEM #	FINISH	SHADE	WATT	SOCKET	BULB
		16620-048	WHITE	OPAL WHITE GLASS	2 X 60W	E26	A19 (Not Included)
		16621-015	WHITE	OPAL WHITE GLASS	1 X 60W	E26	A19 (Not Included)
		16622-012	WHITE	OPAL WHITE GLASS	1 X 60W	E26	A19 (Not Included)

CEILING MOUNT



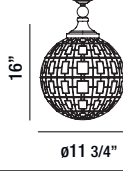









LISO

		ITEM #	FINISH	SHADE	WATT	SOCKET	BULB
		25699-012*	CHROME	OPAL WHITE GLASS	100W	E26	A19 (Not Included)
		25699-029*	SATIN NICKEL	OPAL WHITE GLASS	100W	E26	A19 (Not Included)
		25699-036*	ANTIQU BRASS	OPAL WHITE GLASS	100W	E26	A19 (Not Included)
		25699-043*	OIL RUBBED BRONZE	OPAL WHITE GLASS	100W	E26	A19 (Not Included)

*Comes with 3"+6"+12"+18"+18" Extension Rods



ASPETTO







		ITEM #	FINISH	SHADE	WATT	SOCKET	BULB
		25705-010*	CHROME	OPAL WHITE GLASS	100W	E26	A19 (Not Included)
		25705-027*	SATIN NICKEL	OPAL WHITE GLASS	100W	E26	A19 (Not Included)
		25705-034*	ANTIQUE BRASS	OPAL WHITE GLASS	100W	E26	A19 (Not Included)
		25705-041*	OIL RUBBED BRONZE	OPAL WHITE GLASS	100W	E26	A19 (Not Included)

*Comes with 3"+6"+12"+18"+18" Extension Rods

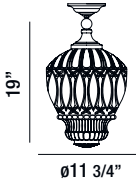

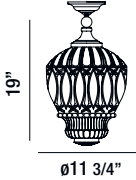

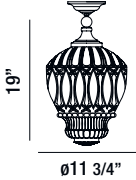
ANTICO

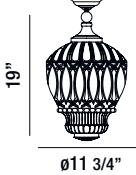
		ITEM #	FINISH	SHADE	WATT	SOCKET	BULB
		25697-018*	CHROME	OPAL WHITE GLASS	100W	E26	A19 (Not Included)
		25697-025*	SATIN NICKEL	OPAL WHITE GLASS	100W	E26	A19 (Not Included)
		25697-032*	ANTIQUE BRASS	OPAL WHITE GLASS	100W	E26	A19 (Not Included)
		25697-049*	OIL RUBBED BRONZE	OPAL WHITE GLASS	100W	E26	A19 (Not Included)

*Comes with 3"+6"+12"+18"+18" Extension Rods



MUSO







		ITEM #	FINISH	SHADE	WATT	SOCKET	BULB
		25703-016*	CHROME	OPAL WHITE GLASS	100W	E26	A19 (Not Included)
		25703-023*	SATIN NICKEL	OPAL WHITE GLASS	100W	E26	A19 (Not Included)
		25703-030*	ANTIQU BRASS	OPAL WHITE GLASS	100W	E26	A19 (Not Included)
		25703-047*	OIL RUBBED BRONZE	OPAL WHITE GLASS	100W	E26	A19 (Not Included)

*Comes with 3"+6"+12"+18"+18" Extension Rods



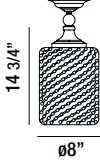

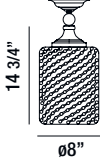



SCALA

		ITEM #	FINISH	SHADE	WATT	SOCKET	BULB
		25701-012*	CHROME	OPAL WHITE GLASS	100W	E26	A19 (Not Included)
		25701-029*	SATIN NICKEL	OPAL WHITE GLASS	100W	E26	A19 (Not Included)
		25701-036*	ANTIQUE BRASS	OPAL WHITE GLASS	100W	E26	A19 (Not Included)
		25701-043*	OIL RUBBED BRONZE	OPAL WHITE GLASS	100W	E26	A19 (Not Included)

*Comes with 3"+6"+12"+18"+18" Extension Rods

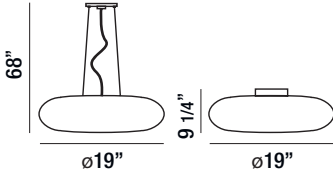

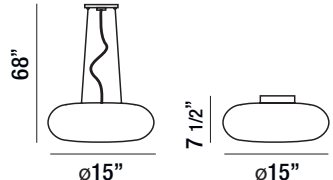
POP

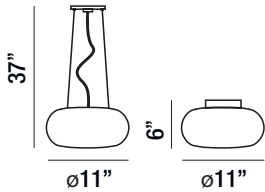
		ITEM #	FINISH	SHADE	WATT	SOCKET	BULB
 	23194-014*	CHROME	OPAL WHITE GLASS	3 X 60W	E26	A19 (Not included)	
 	12895-052*	CHROME	OPAL WHITE GLASS	3 X 60W	E26	A19 (Not included)	
 	12894-055*	CHROME	OPAL WHITE GLASS	2 X 60W	E26	A19 (Not included)	







*2 in 1 Convertible Pendant to Flushmount

CEILING MOUNT

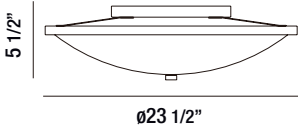

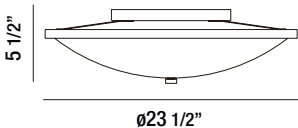

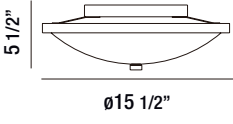

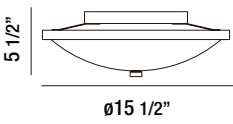
BLANKO

		ITEM #	FINISH	SHADE	WATT	SOCKET	BULB
 		20371-012	ANTIQU BRASS	OPAL WHITE GLASS	5 X 60W	E26	A19 (Not Included)
 		20371-029	SATIN NICKEL	OPAL WHITE GLASS	5 X 60W	E26	A19 (Not Included)
 		20370-015	ANTIQU BRASS	OPAL WHITE GLASS	3 X 60W	E26	A19 (Not Included)
 		20370-022	SATIN NICKEL	OPAL WHITE GLASS	3 X 60W	E26	A19 (Not Included)

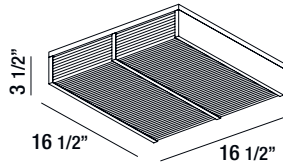

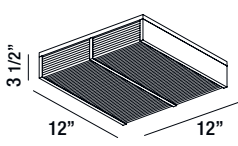
		ITEM #	KELVIN	FINISH	SHADE	WATT	LUMEN	CRI	DIMMABLE
 		31811-019	3000K	CHROME	CLEAR GLASS	36W LED	1780lm	80+	TRIAC
 		31810-012	3000K	CHROME	CLEAR GLASS	28W LED	1330lm	80+	TRIAC

For customization please consult Eurofase

CEILING MOUNT





SPHERE

	ITEM #	KELVIN	FINISH	SHADE	WATT	LUMEN	CRI	DIMMABLE
	25676-013	3200K	CHROME	CLEAR FROSTED GLASS	9 X 2.3W LED	1287lm	85+	NO

For customization please consult Eurofase



CUBE



ITEM #	KELVIN	FINISH	SHADE	WATT	LUMEN	CRI	DIMMABLE
--------	--------	--------	-------	------	-------	-----	----------

25675-016	3200K	CHROME	CLEAR FROSTED GLASS	6 X 2.3W LED	858lm	85+	NO
-----------	-------	--------	---------------------	--------------	-------	-----	----





For customization please consult Eurofase

CEILING MOUNT



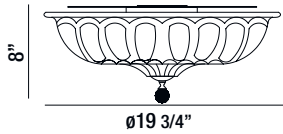

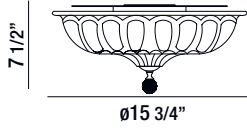

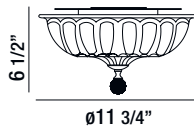
VINTAGE

		ITEM #	FINISH	SHADE	WATT	SOCKET	BULB
		22944-016	CHROME	CLEAR GLASS	3 X 60W	E12	B10 (Not Included)
		22943-019	CHROME	CLEAR GLASS	3 X 60W	E12	B10 (Not Included)
		22942-012	CHROME	CLEAR GLASS	2 X 60W	E12	B10 (Not Included)

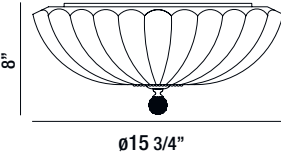

AURORA

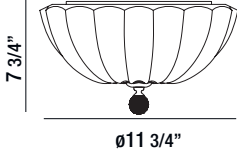

		ITEM #	FINISH	SHADE	WATT	SOCKET	BULB
	 <p>8" ø15 3/4"</p>	23223-011	CHROME	CLEAR GLASS	3 X 60W	E12	B10 (Not Included)
	 <p>7 3/4" ø11 3/4"</p>	23222-014	CHROME	CLEAR GLASS	2 X 60W	E12	B10 (Not Included)

CEILING MOUNT



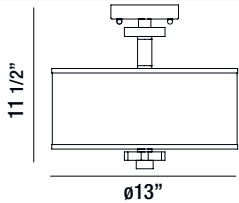

SAVVY

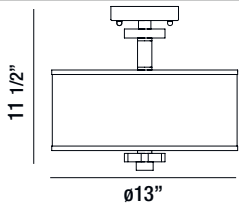
		ITEM #	FINISH	SHADE	WATT	SOCKET	BULB
		15330-021	SATIN NICKEL	BROWN FAUX-SUEDE DRUM	3 X 60W	E26	A19 (Not Included)
		15330-045	SATIN NICKEL	WHITE FAUX-SUEDE DRUM	3 X 60W	E26	A19 (Not Included)



ZINCO

	ITEM #	FINISH	SHADE	WATT	SOCKET	BULB
 	30033-016*	AGED SILVER	METAL	60W	E26	EDISON BULB (Included)

*Comes with 3"+6"+12"+18" Extension Rods

OPTIONS			INCLUDED		
					

CEILING MOUNT

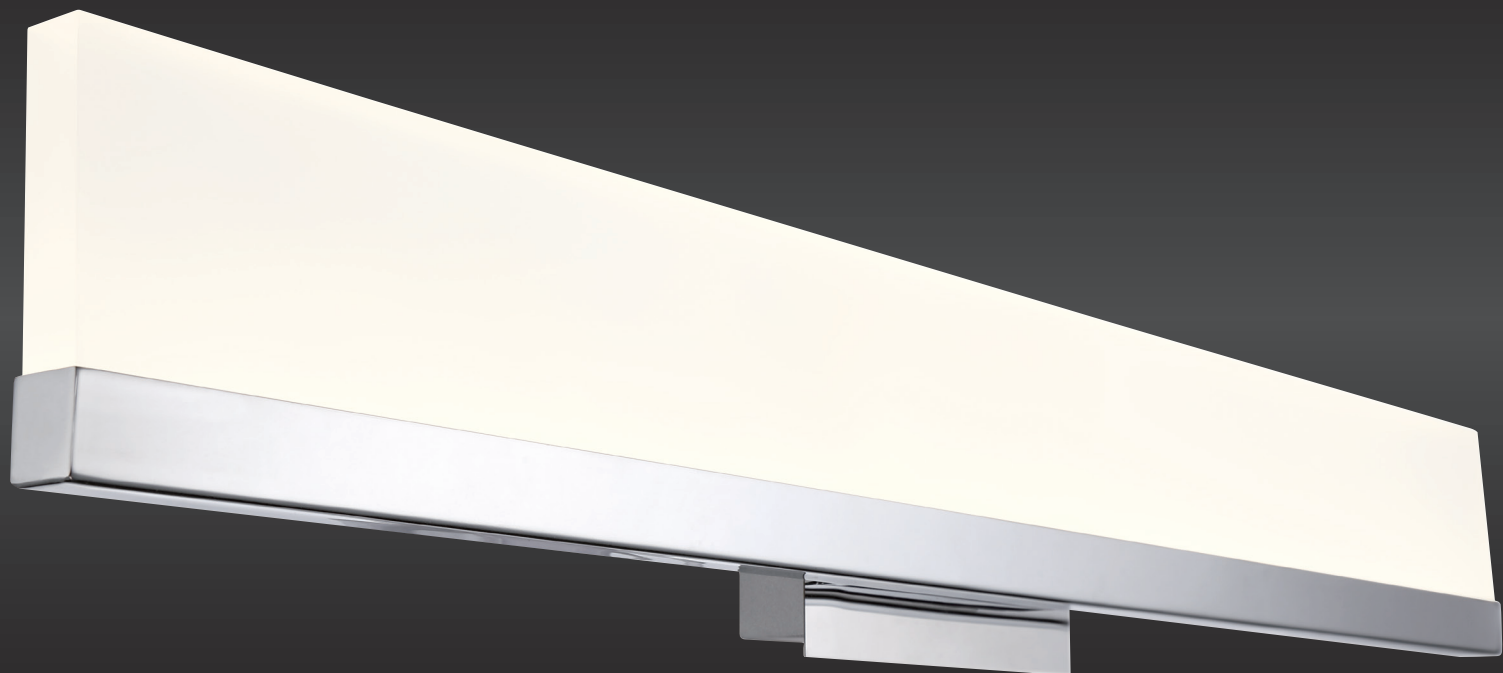

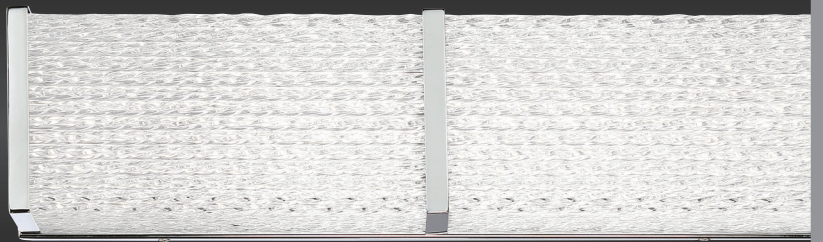
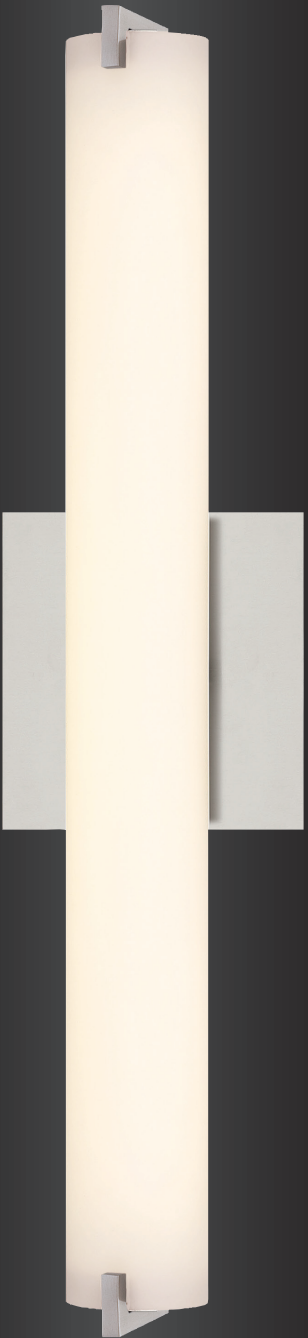
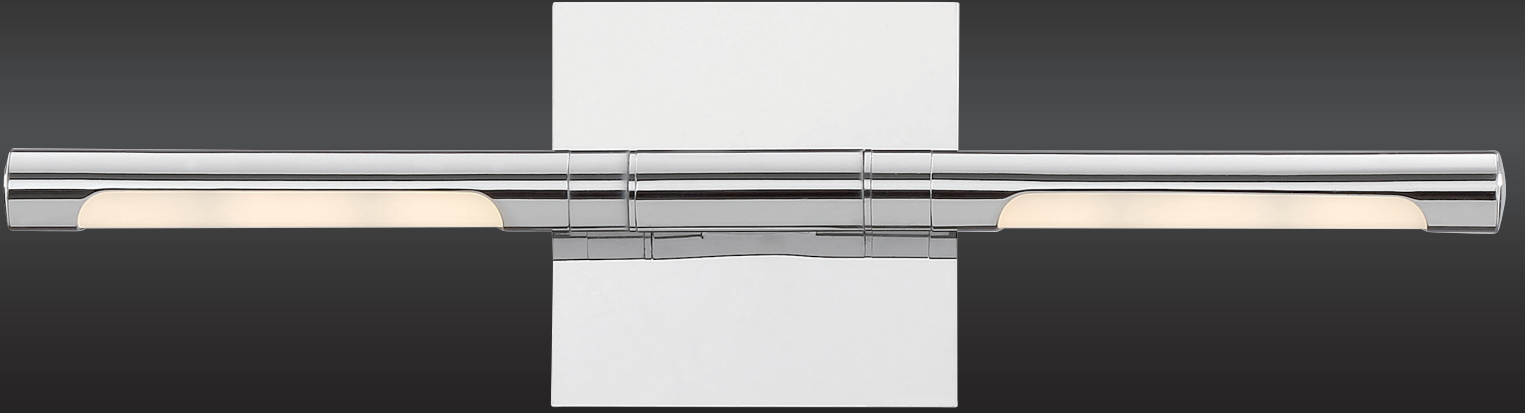

WALL MOUNT





VIOLA

ITEM #	KELVIN	FINISH	SHADE	WATT	LUMEN	CRI	DIMMABLE	INSTALLATION
--------	--------	--------	-------	------	-------	-----	----------	--------------

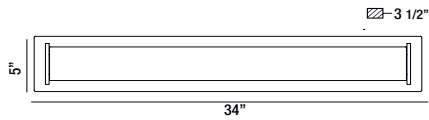

31637-015	3000K	CHROME	WHITE ACRYLIC	36W LED	2240lm	80+	TRIAC	VERTICAL AND HORIZONTAL
-----------	-------	--------	------------------	------------	--------	-----	-------	-------------------------------

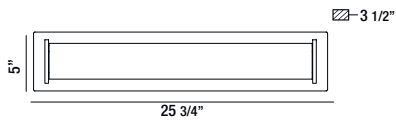

31636-018	3000K	CHROME	WHITE ACRYLIC	27W LED	1680lm	80+	TRIAC	VERTICAL AND HORIZONTAL
-----------	-------	--------	------------------	------------	--------	-----	-------	-------------------------------

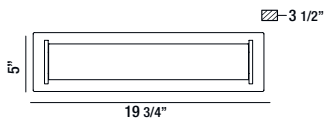

31635-011	3000K	CHROME	WHITE ACRYLIC	19W LED	1120lm	80+	TRIAC	VERTICAL AND HORIZONTAL
-----------	-------	--------	------------------	------------	--------	-----	-------	-------------------------------

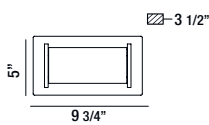

31634-014	3000K	CHROME	WHITE ACRYLIC	7W LED	420lm	80+	TRIAC	VERTICAL AND HORIZONTAL
-----------	-------	--------	------------------	-----------	-------	-----	-------	-------------------------------

For customization please consult Eurofase



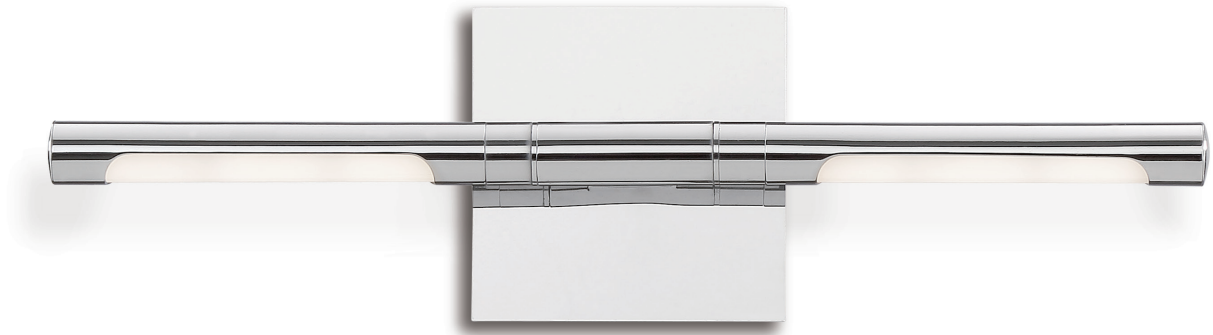

PHILIP

	ITEM #	KELVIN	FINISH	SHADE	WATT	LUMEN	CRI	DIMMABLE	INSTALLATION
	32878-011	3000K	CHROME	FROSTED ACRYLIC	17W LED	1780lm	80+	TRIAC	VERTICAL AND HORIZONTAL
	32877-014	3000K	CHROME	FROSTED ACRYLIC	12W LED	1260lm	80+	TRIAC	VERTICAL AND HORIZONTAL
	32876-017	3000K	CHROME	FROSTED ACRYLIC	9W LED	945lm	80+	TRIAC	VERTICAL AND HORIZONTAL
	32875-010	3000K	CHROME	FROSTED ACRYLIC	6W LED	630lm	80+	TRIAC	VERTICAL AND HORIZONTAL

For customization please consult Eurofase



ANELLO

	ITEM #	KELVIN	FINISH	SHADE	WATT	LUMEN	CRI	DIMMABLE	INSTALLATION
 	32124-019*	3000K	CHROME	FROSTED GLASS	48W LED	4800lm	80+	TRIAC	VERTICAL AND HORIZONTAL
 	32123-012*	3000K	CHROME	FROSTED GLASS	40W LED	3600lm	80+	TRIAC	VERTICAL AND HORIZONTAL
 	32122-015*	3000K	CHROME	FROSTED GLASS	27W LED	2400lm	80+	TRIAC	VERTICAL AND HORIZONTAL
 	32121-018*	3000K	CHROME	FROSTED GLASS	13W LED	1200lm	80+	TRIAC	VERTICAL AND HORIZONTAL

WALL MOUNT





* Up/Down Lighting

For customization please consult Eurofase



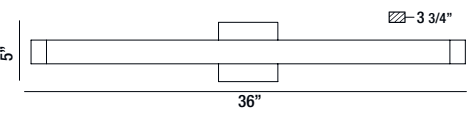

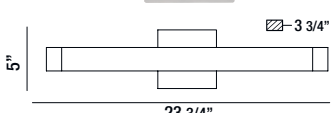
MONI

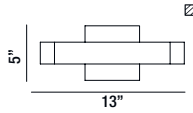



	ITEM #	KELVIN	FINISH	SHADE	WATT	LUMEN	CRI	DIMMABLE	INSTALLATION
 	31819-015*	3000K	ALUMINUM	FROSTED GLASS	21W LED	2040lm	80+	TRIAC	VERTICAL AND HORIZONTAL
 	31818-018*	3000K	ALUMINUM	FROSTED GLASS	14W LED	1270lm	80+	TRIAC	VERTICAL AND HORIZONTAL
 	31817-011*	3000K	ALUMINUM	FROSTED GLASS	9W LED	850lm	80+	TRIAC	VERTICAL AND HORIZONTAL

* Up/Down Lighting

For customization please consult Eurofase

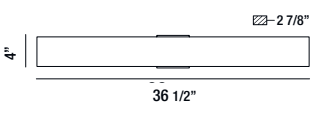

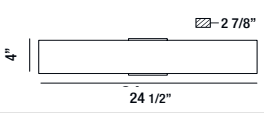
EXPO

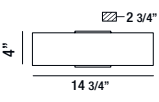
	ITEM #	KELVIN	FINISH	SHADE	WATT	LUMEN	CRI	DIMMABLE	INSTALLATION
 	30145-016*	3000K	ALUMINUM	ALUMINUM	20W LED	1700lm	80+	TRIAC	VERTICAL AND HORIZONTAL
 	30144-019*	3000K	ALUMINUM	ALUMINUM	12W LED	1020lm	80+	TRIAC	VERTICAL AND HORIZONTAL
 	30143-012*	3000K	ALUMINUM	ALUMINUM	6W LED	510lm	80+	TRIAC	VERTICAL AND HORIZONTAL

WALL MOUNT

* Up/Down Lighting

For customization please consult Eurofase





SAVONA

ITEM # KELVIN FINISH SHADE WATT LUMEN CRI DIMMABLE INSTALLATION

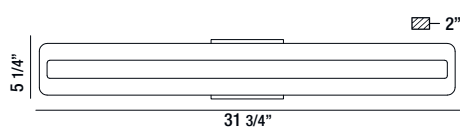

31812-016 3000K CHROME FROSTED ACRYLIC 24W LED 1600lm 80+ TRIAC VERTICAL AND HORIZONTAL

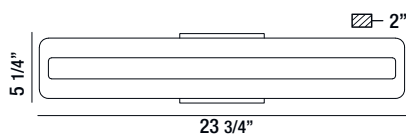



30185-012 3000K CHROME FROSTED ACRYLIC 12W LED 1200lm 80+ TRIAC VERTICAL AND HORIZONTAL

For customization please consult Eurofase

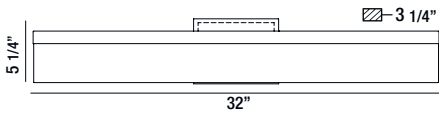

SOLE

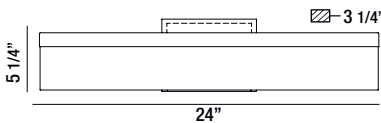
	ITEM #	KELVIN	FINISH	SHADE	WATT	LUMEN	CRI	DIMMABLE	INSTALLATION
 	31805-018	3000K	CHROME	FROSTED ACRYLIC	30W LED	2850lm	80+	TRIAC	UPWARD AND DOWNWARD
 	31804-011	3000K	CHROME	FROSTED ACRYLIC	23W LED	2185lm	80+	TRIAC	UPWARD AND DOWNWARD

For customization please consult Eurofase



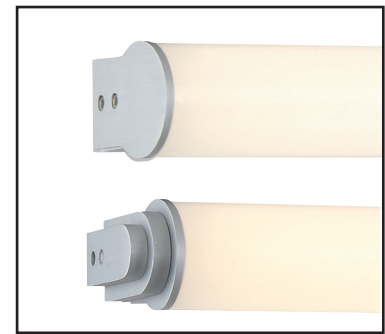

BOTH END CAPS INCLUDED





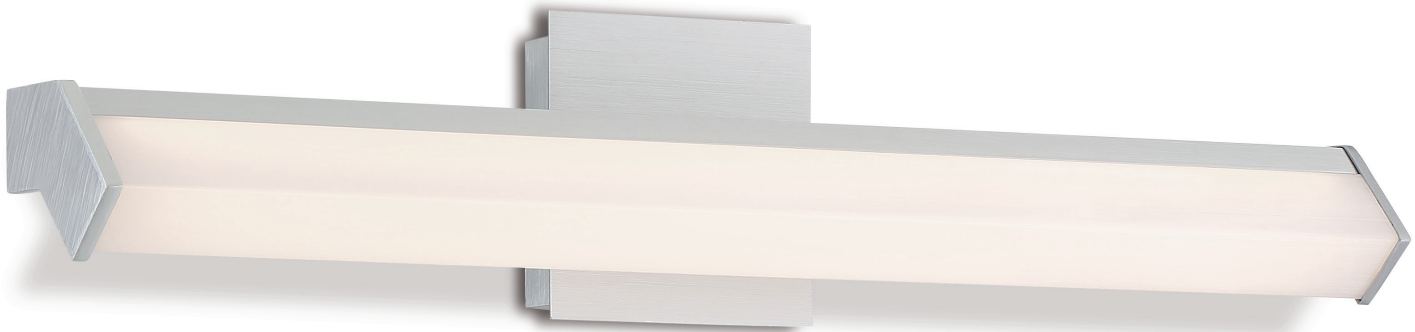

RAY

	ITEM #	KELVIN	FINISH	SHADE	WATT	LUMEN	CRI	DIMMABLE	INSTALLATION
	31814-010	3000K	ALUMINUM	WHITE ACRYLIC	16W LED	1445lm	80+	TRIAC	VERTICAL AND HORIZONTAL
	30190-016	3000K	ALUMINUM	WHITE ACRYLIC	10W LED	1020lm	80+	TRIAC	VERTICAL AND HORIZONTAL
	30191-013	3000K	ALUMINUM	WHITE ACRYLIC	7W LED	680lm	80+	TRIAC	VERTICAL AND HORIZONTAL

For customization please consult Eurofase

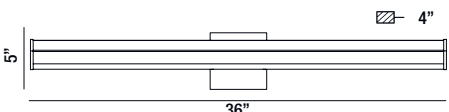

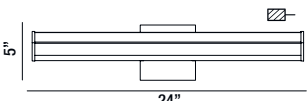
ARCO

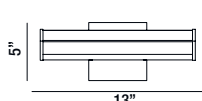
	ITEM #	KELVIN	FINISH	SHADE	WATT	LUMEN	CRI	DIMMABLE	INSTALLATION
 	30194-014	3000K	ALUMINUM	WHITE ACRYLIC	16W LED	1445lm	80+	TRIAC	DOWNWARD
 	31816-014	3000K	ALUMINUM	WHITE ACRYLIC	10W LED	1020lm	80+	TRIAC	DOWNWARD
 	30195-011	3000K	ALUMINUM	WHITE ACRYLIC	7W LED	680lm	80+	TRIAC	DOWNWARD

WALL MOUNT

For customization please consult Eurofase







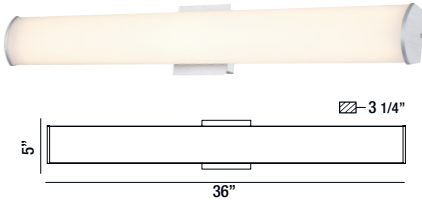
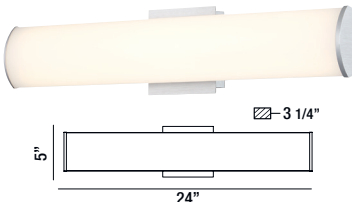
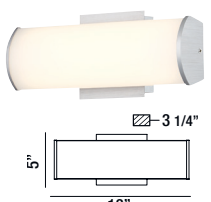

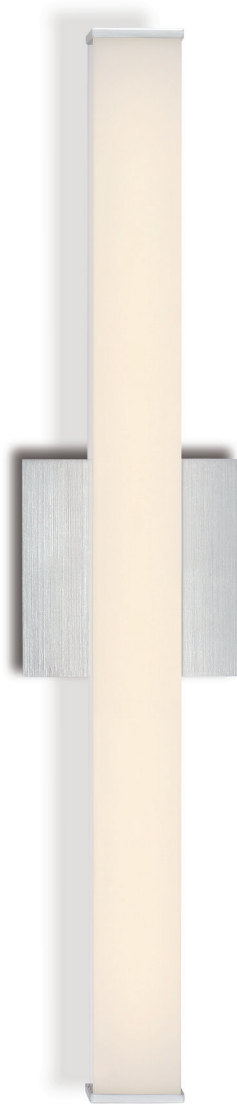

AIM

	ITEM #	KELVIN	FINISH	SHADE	WATT	LUMEN	CRI	DIMMABLE	INSTALLATION
 <p>Technical drawing of a 36 inch light fixture showing a diameter of 3 1/4 inches and a length of 36 inches.</p>	31813-013	3000K	ALUMINUM	WHITE ACRYLIC	21W LED	2040lm	80+	TRIAC	VERTICAL AND HORIZONTAL
 <p>Technical drawing of a 24 inch light fixture showing a diameter of 3 1/4 inches and a length of 24 inches.</p>	30187-016	3000K	ALUMINUM	WHITE ACRYLIC	14W LED	1275lm	80+	TRIAC	VERTICAL AND HORIZONTAL
 <p>Technical drawing of a 13 inch light fixture showing a diameter of 3 1/4 inches and a length of 13 inches.</p>	30188-013	3000K	ALUMINUM	WHITE ACRYLIC	9W LED	850lm	80+	TRIAC	VERTICAL AND HORIZONTAL

For customization please consult Eurofase

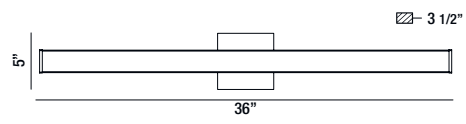

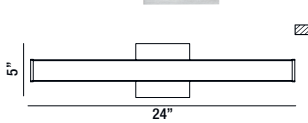
KELVIN

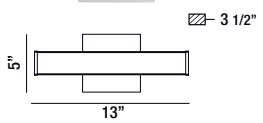
	ITEM #	KELVIN	FINISH	SHADE	WATT	LUMEN	CRI	DIMMABLE	INSTALLATION
 	30192-010	3000K	ALUMINUM	WHITE ACRYLIC	16W LED	1440lm	80+	TRIAC	VERTICAL AND HORIZONTAL
 	31815-017	3000K	ALUMINUM	WHITE ACRYLIC	10W LED	1020lm	80+	TRIAC	VERTICAL AND HORIZONTAL
 	30193-017	3000K	ALUMINUM	WHITE ACRYLIC	7W LED	680lm	80+	TRIAC	VERTICAL AND HORIZONTAL





WALL MOUNT

For customization please consult Eurofase



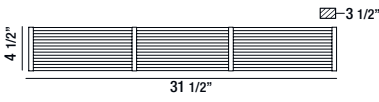

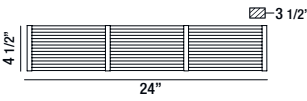
WYNN

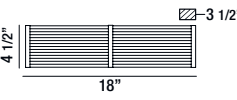
	ITEM #	KELVIN	FINISH	SHADE	WATT	LUMEN	CRI	DIMMABLE	INSTALLATION
 	31444-019	3000K	CHROME	CLEAR GLASS	38W LED	4000lm	80+	TRIAC	VERTICAL AND HORIZONTAL
 	31443-012	3000K	CHROME	CLEAR GLASS	26W LED	2400lm	80+	TRIAC	VERTICAL AND HORIZONTAL
 	31442-015	3000K	CHROME	CLEAR GLASS	20W LED	1600lm	80+	TRIAC	VERTICAL AND HORIZONTAL

For customization please consult Eurofase

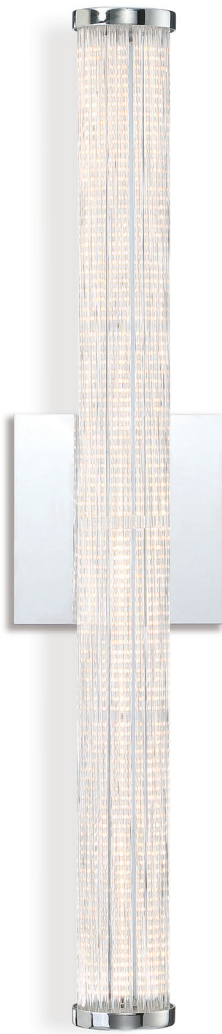

BRAID



	ITEM #	KELVIN	FINISH	SHADE	WATT	LUMEN	CRI	DIMMABLE	INSTALLATION
	31809-016	3000K	CHROME	CLEAR GLASS	22W LED	2090lm	80+	TRIAC	VERTICAL AND HORIZONTAL
	31808-019	3000K	CHROME	CLEAR GLASS	16W LED	1520lm	80+	TRIAC	VERTICAL AND HORIZONTAL
	31807-012	3000K	CHROME	CLEAR GLASS	12W LED	1140lm	80+	TRIAC	VERTICAL AND HORIZONTAL

For customization please consult Eurofase

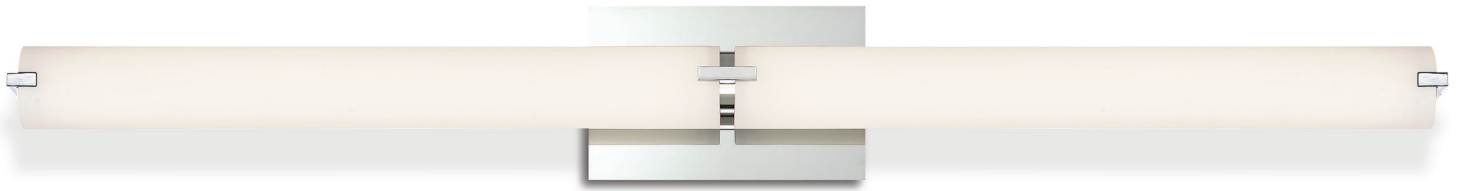



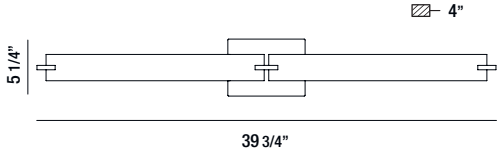

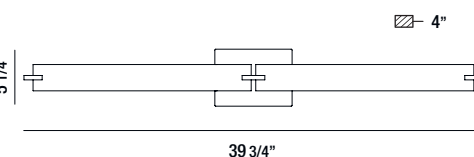

ZUMA

	ITEM #	KELVIN	FINISH	SHADE	WATT	LUMEN	CRI	DIMMABLE	INSTALLATION
 	30180-017	3000K	CHROME	OPAL WHITE GLASS	30W LED	2550lm	80+	TRIAC	VERTICAL AND HORIZONTAL
 	30180-024	3000K	SATIN NICKEL	OPAL WHITE GLASS	30W LED	2550lm	80+	TRIAC	VERTICAL AND HORIZONTAL

For customization please consult Eurofase

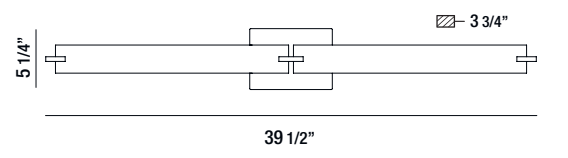

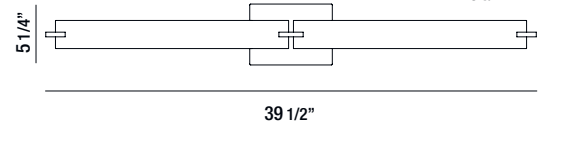
ZUMA

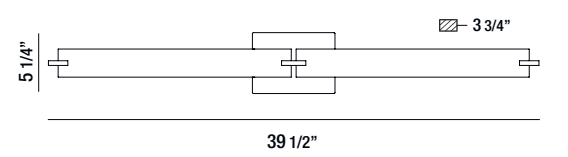
	ITEM #	FINISH	SHADE	WATT	SOCKET	BULB	INSTALLATION
 	23273-016	CHROME	OPAL WHITE GLASS	6 X 40W	G9	G9 (Included)	VERTICAL AND HORIZONTAL
 	23273-023	BRUSHED NICKEL	OPAL WHITE GLASS	6 X 40W	G9	G9 (Included)	VERTICAL AND HORIZONTAL
 	23273-030	OIL RUBBED BRONZE	OPAL WHITE GLASS	6 X 40W	G9	G9 (Included)	VERTICAL AND HORIZONTAL

WALL MOUNT



ZUMA

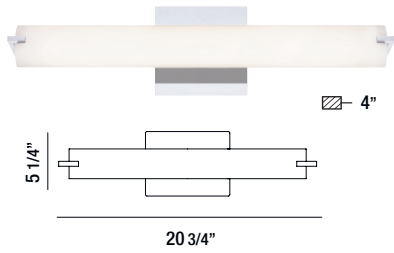

ITEM #	KELVIN	FINISH	SHADE	WATT	LUMEN	CRI	DIMMABLE	INSTALLATION
30179-011	3200K	CHROME	OPAL WHITE GLASS	15W LED	1270lm	80+	TRIAC	VERTICAL AND HORIZONTAL

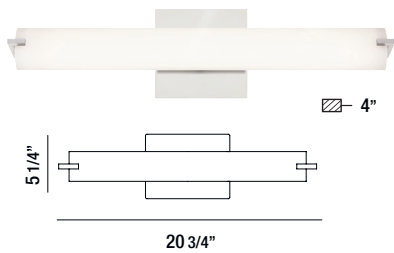

30179-028	3200K	SATIN NICKEL	OPAL WHITE GLASS	15W LED	1270lm	80+	TRIAC	VERTICAL AND HORIZONTAL
-----------	-------	--------------	------------------	---------	--------	-----	-------	-------------------------

For customization please consult Eurofase





ZUMA

	ITEM #	FINISH	SHADE	WATT	SOCKET	BULB	INSTALLATION
 	23272-019	CHROME	OPAL WHITE GLASS	3 X 40W	G9	G9 (Included)	VERTICAL AND HORIZONTAL
 	23272-026	BRUSHED NICKEL	OPAL WHITE GLASS	3 X 40W	G9	G9 (Included)	VERTICAL AND HORIZONTAL
 	23272-033	OIL RUBBED BRONZE	OPAL WHITE GLASS	3 X 40W	G9	G9 (Included)	VERTICAL AND HORIZONTAL

WALL MOUNT

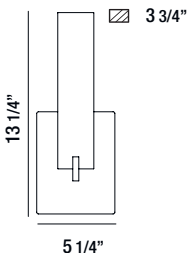

ZUMA

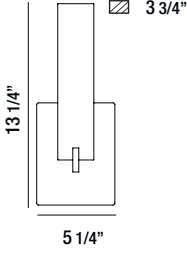
ITEM #	KELVIN	FINISH	SHADE	WATT	LUMEN	CRI	DIMMABLE	INSTALLATION	
 	30181-014	3200K	CHROME	OPAL WHITE GLASS	8W LED	680lm	80+	TRIAC	UPWARD
 	30181-021	3200K	SATIN NICKEL	OPAL WHITE GLASS	8W LED	680lm	80+	TRIAC	UPWARD

For customization please consult Eurofase



ZUMA

	ITEM #	FINISH	SHADE	WATT	SOCKET	BULB	INSTALLATION
	23271-012	CHROME	OPAL WHITE GLASS	2 X 40W	G9	G9 (Included)	UPWARD
	23271-029	BRUSHED NICKEL	OPAL WHITE GLASS	2 X 40W	G9	G9 (Included)	UPWARD
	23271-036	OIL RUBBED BRONZE	OPAL WHITE GLASS	2 X 40W	G9	G9 (Included)	UPWARD

WALL MOUNT



ABSOLVE

ITEM # KELVIN FINISH SHADE WATT LUMEN CRI DIMMABLE INSTALLATION

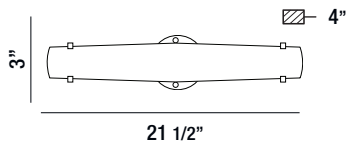

33228-013 3000K CHROME OPAL WHITE GLASS 20W LED 1600lm 80+ TRIAC VERTICAL AND HORIZONTAL

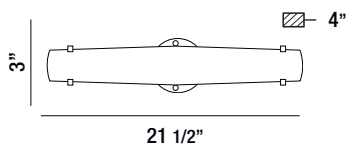

33228-020 3000K SATIN NICKEL OPAL WHITE GLASS 20W LED 1600lm 80+ TRIAC VERTICAL AND HORIZONTAL

For customization please consult Eurofase



MEDIA

ITEM #	KELVIN	FINISH	SHADE	WATT	LUMEN	CRI	DIMMABLE	INSTALLATION
30147-010	3000K	CHROME	WHITE ACRYLIC	9W LED	790lm	80+	TRIAC	VERTICAL AND HORIZONTAL

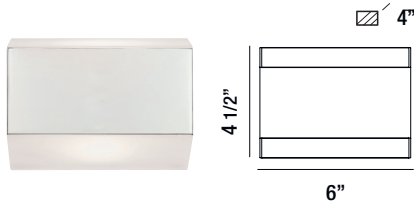

For customization please consult Eurofase



ARCH

ITEM #	KELVIN	FINISH	SHADE	WATT	LUMEN	CRI	DIMMABLE	INSTALLATION
30148-017	3000K	CHROME	WHITE ACRYLIC	9W LED	790lm	80+	TRIAC	VERTICAL AND HORIZONTAL

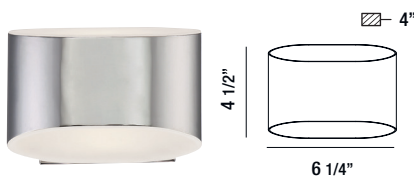

For customization please consult Eurofase



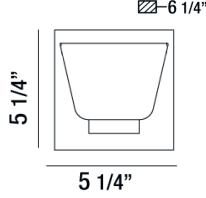

TRENT

	ITEM #	KELVIN	FINISH	SHADE	WATT	LUMEN	CRI	DIMMABLE	INSTALLATION
 	31800-013	3000K	CHROME	CLEAR GLASS	7W LED	750lm	80+	TRIAC	UPWARD

For customization please consult Eurofase

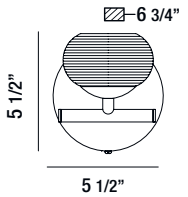

MARCHE

	ITEM #	KELVIN	FINISH	SHADE	WATT	LUMEN	CRI	DIMMABLE	INSTALLATION
 	31793-018	3000K	CHROME	FROSTED GLASS	7W LED	840lm	80+	TRIAC	UPWARD

For customization please consult Eurofase



SONIC

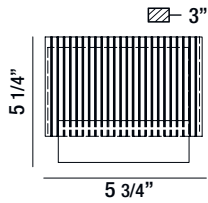

ITEM #	KELVIN	FINISH	SHADE	WATT	LUMEN	CRI	DIMMABLE	INSTALLATION
31438-018	4000K	CHROME	CLEAR ACRYLIC	6W LED	500lm	80+	TRIAC	UPWARD

For customization please consult Eurofase



ANCONA

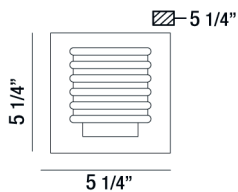

ITEM #	KELVIN	FINISH	SHADE	WATT	LUMEN	CRI	DIMMABLE	INSTALLATION
31789-011	3000K	CHROME	CLEAR ACRYLIC	10W LED	1020lm	80+	TRIAC	UPWARD

For customization please consult Eurofase





OLSON

ITEM #	KELVIN	FINISH	SHADE	WATT	LUMEN	CRI	DIMMABLE	INSTALLATION
28019-015	3000K	CHROME	FROSTED ACRYLIC	5W LED	350lm	80+	TRIAC	VERTICAL AND HORIZONTAL

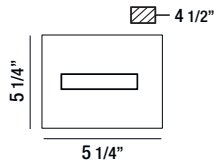

For customization please consult Eurofase

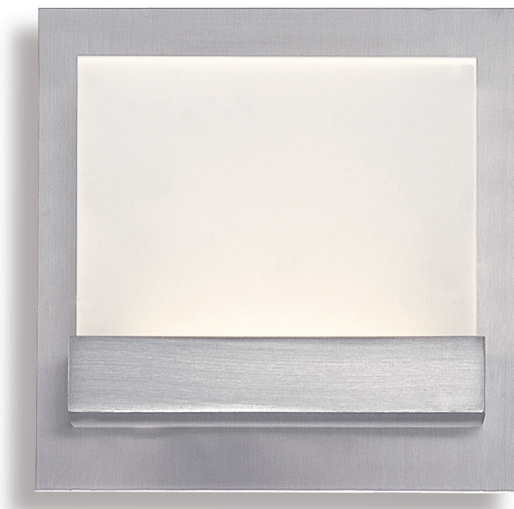

HARMEN

ITEM #	KELVIN	FINISH	SHADE	WATT	LUMEN	CRI	DIMMABLE	INSTALLATION
28023-012	3000K	SATIN NICKEL	FROSTED ACRYLIC	5W LED	350lm	80+	TRIAC	UPWARD

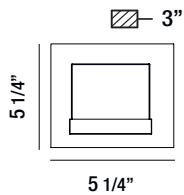

For customization please consult Eurofase



DAKOTA

ITEM # KELVIN FINISH SHADE WATT LUMEN CRI DIMMABLE INSTALLATION

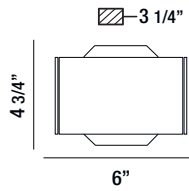

30089-013 3000K CHROME FROSTED GLASS 5W LED 380lm 80+ TRIAC UPWARD

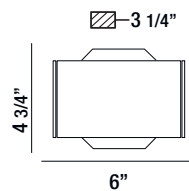



30089-020 3000K SATIN NICKEL FROSTED GLASS 5W LED 380lm 80+ TRIAC UPWARD

For customization please consult Eurofase



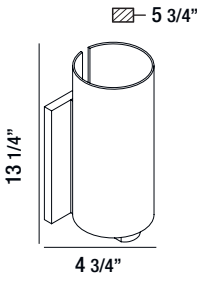

PILOS

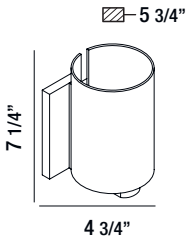
	ITEM #	KELVIN	FINISH	SHADE	WATT	LUMEN	CRI	DIMMABLE	INSTALLATION
 	33229-010	3000K	CHROME	OPAL WHITE GLASS	12W LED	800lm	80+	TRIAC	UPWARD
 	33230-016	3000K	CHROME	OPAL WHITE GLASS	6W LED	400lm	80+	TRIAC	UPWARD

For customization please consult Eurofase



DELROY

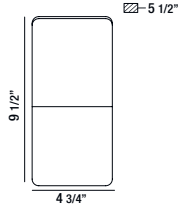

ITEM #	KELVIN	FINISH	SHADE	WATT	LUMEN	CRI	DIMMABLE	INSTALLATION
30146-013	3000K	ALUMINUM	ALUMINUM	5W LED	425lm	80+	TRIAC	UPWARD

For customization please consult Eurofase



PALERMO

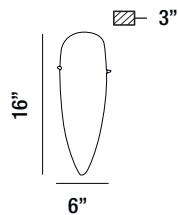

ITEM #	KELVIN	FINISH	SHADE	WATT	LUMEN	CRI	DIMMABLE	INSTALLATION
33231-013	3000K	SATIN NICKEL	OPAL WHITE GLASS	12W LED	800lm	80+	TRIAC	UPWARD

For customization please consult Eurofase





VESPER

	ITEM #	FINISH	SHADE	WATT	SOCKET	BULB	INSTALLATION
	23274-013	CHROME	OPAL WHITE GLASS	2 X 60W	E26	T10 (Not Included)	VERTICAL AND HORIZONTAL
	23274-020	BRUSHED NICKEL	OPAL WHITE GLASS	2 X 60W	E26	T10 (Not Included)	VERTICAL AND HORIZONTAL



VESPER

	ITEM #	FINISH	SHADE	WATT	SOCKET	BULB	INSTALLATION
	23275-010	CHROME	OPAL WHITE GLASS	60W	E26	T10 (Not Included)	UPWARD
	23275-027	BRUSHED NICKEL	OPAL WHITE GLASS	60W	E26	T10 (Not Included)	UPWARD

WALL MOUNT

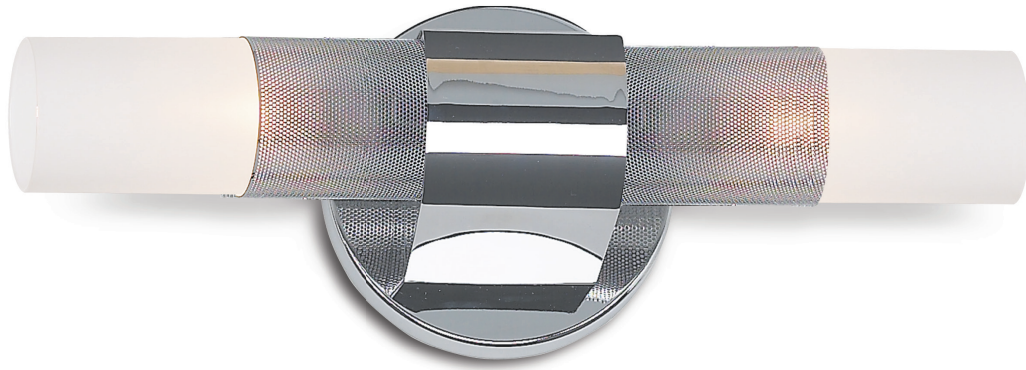

DONNA

	ITEM #	FINISH	SHADE	WATT	SOCKET	BULB	INSTALLATION
	BR-2DON-05	CHROME	FROSTED GLASS	2 X 60W	E26	T10 (Not Included)	VERTICAL AND HORIZONTAL



UOMO

	ITEM #	FINISH	SHADE	WATT	SOCKET	BULB	INSTALLATION
	BR-1UOMO-05	CHROME	FROSTED GLASS	60W	E26	T10	UPWARD



SYDNEY

	ITEM #	FINISH	SHADE	WATT	SOCKET	BULB	INSTALLATION
	SC-2SNE-25	CHROME	OPAL WHITE GLASS	2 X 60W	E26	B13 (Not Included)	VERTICAL AND HORIZONTAL



SYDNEY

	ITEM #	FINISH	SHADE	WATT	SOCKET	BULB	INSTALLATION
	SC-1SNE-25	CHROME	OPAL WHITE GLASS	60W	E26	B13 (Not Included)	UPWARD

WALL MOUNT



VITA

	ITEM #	FINISH	SHADE	WATT	SOCKET	BULB	INSTALLATION
	7279-25	CHROME	OPAL WHITE GLASS	60W	E26	A19 (Not Included)	UPWARD





MAROND

	ITEM #	FINISH	SHADE	WATT	SOCKET	BULB	INSTALLATION
	19414-010	CHROME	OPAL WHITE GLASS	60W	G9	G9 (Included)	UPWARD

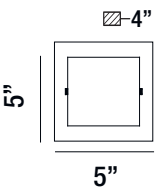

TALO

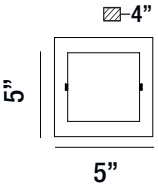
	ITEM #	FINISH	SHADE	WATT	SOCKET	BULB	INSTALLATION
 	19424-019	CHROME	OPAL WHITE GLASS	60W	G9	G9 (Included)	UPWARD
 	19424-026	SATIN NICKEL	OPAL WHITE GLASS	60W	G9	G9 (Included)	UPWARD

WALL MOUNT

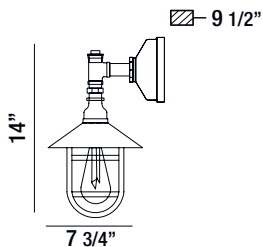

ZINCO

	ITEM #	FINISH	SHADE	WATT	SOCKET	BULB	INSTALLATION
 	30032-019	AGED SILVER	METAL	60W	E26	EDISON BULB (Included)	DOWNWARD

OPTIONS			INCLUDED		
					

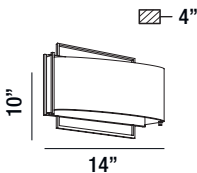

STRADA

	ITEM #	FINISH	SHADE	WATT	SOCKET	BULB	INSTALLATION
 	25596-014	BRONZE	BELGIAN LINEN	2 X 60W	E26	B13	UPWARD



SOLO

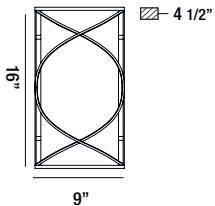



	ITEM #	FINISH	SHADE	WATT	SOCKET	BULB	INSTALLATION
 	23070-011	BRUSHED NICKEL	WHITE FABRIC	2 X 60W	E26	A19	UPWARD

WALL MOUNT



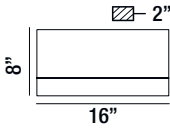

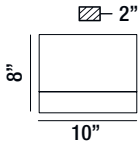
HALPERN

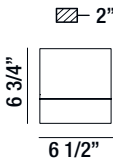
	ITEM #	FINISH	SHADE	WATT	LUMEN	KELVIN	CRI	DIMMABLE	INSTALLATION
 	31437-011*	PLATINUM	CLEAR ACRYLIC	6W LED	510lm	4000K	80+	NO	UPWARD
 	31436-014*	PLATINUM	CLEAR ACRYLIC	4W LED	340lm	4000K	80+	NO	UPWARD
 	31435-017*	PLATINUM	CLEAR ACRYLIC	3W LED	255lm	4000K	80+	NO	UPWARD

* Mounts in standard 2" x 3" outlet box (Not included)

* FOR CUSTOMIZATION PLEASE CONSULT EUROFASE



 PARA

ITEM #	FINISH	SHADE	WATT	LUMEN	KELVIN	CRI	DIMMABLE	INSTALLATION
30168-015*	CHROME	CLEAR ACRYLIC	2W LED	170lm	3000K	80+	NO	UPWARD

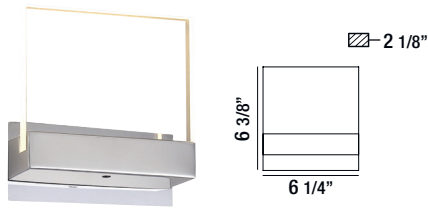

* CONTACT EUROFASE FOR CUSTOM DESIGNS



WALL MOUNT